

# DOOR CLOSERS

**1900 SERIES**  
GRADE 1 - BUILDER PACK

**Taymor**

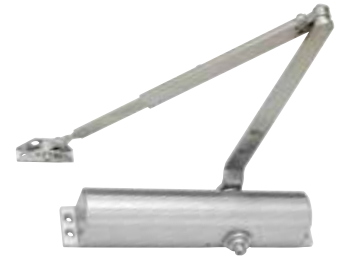

WITHOUT PLASTIC COVER

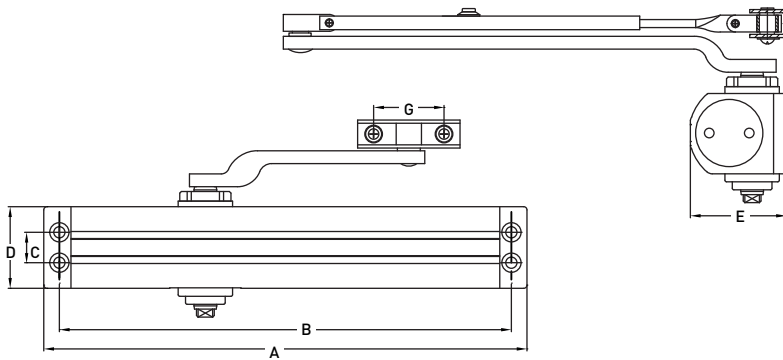

	A	B	C	D	E	F
13-1900AL	11-7/8" [302 mm]	11-1/8" [282.5 mm]	3/4" [19 mm]	2" [51 mm]	2-3/8" [60 mm]	1-3/4" [44 mm]

## FEATURES

- UL AND c-UL LISTED COMPLIANT UL10C FOR POSITIVE PRESSURE
- ANSI A156.4 - GRADE 1
- POWER ADJUSTABLE 1-6
- STANDARD BARRIER FREE OPERATION (COMPLIES WITH ADA)
- STANDARD BACKCHECK, STANDARD SWEEP AND LATCHING SPEED
- STANDARD DELAYED ACTION ON 13-1900BFDAAL MODEL
- NON-HANDED INSTALLATION
- CAST ALUMINUM BODY
- HIGH GRADE QUALITY PLASTIC COVER
- UNIVERSAL MOUNTING - REGULAR & PARALLEL BRACKET INCLUDED
- RACK AND PINION MECHANISM
- STABLE HYDRAULIC FLUID FOR ANY CLIMATE OPERATION & CONSTANT LUBRICATION FROM -42°C TO +55°C
- 10 YEAR MECHANICAL AND 1 YEAR FINISH WARRANTY



### 1900 SERIES DOOR CLOSER - BUILDER PACK

MAXIMUM RECOMMENDED DOOR SIZE & WEIGHT	ALUMINUM	CASE PACK
48" x 96" - [121 cm x 243 cm] 266 lbs - [121 kg]	13-1900AL	6
48" x 96" - [121 cm x 243 cm] 266 lbs - [121 kg]	13-1900BFDAAL	6

ADJUSTABLE POWER 1 THROUGH 6 WITH STANDARD BACKCHECK AND BARRIER FREE

48" x 96" - [121 cm x 243 cm]  
266 lbs - [121 kg]

13-1900AL









6

ADJUSTABLE POWER 1 THROUGH 6 WITH STANDARD BACKCHECK, BARRIER FREE AND DELAYED ACTION

48" x 96" - [121 cm x 243 cm]  
266 lbs - [121 kg]

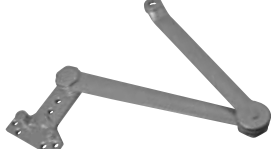
13-1900BFDAAL

6

1900 SERIES DOOR CLOSER ACCESSORIES	DESCRIPTION	ALUMINUM	CASE PACK
	REGULAR OR TOP JAMB NARROW DROP PLATE - 2" TALL (51 mm)	13-A1900DP51AL	10
	PARALLEL ARM DROP PLATE - 3-9/16" TALL (90 mm)	13-A1900DP90AL	10
	PARALLEL ARM BRACKET FOR FRICTION HOLD OPEN ARM	13-A1900PAFHOAL	10
	PARALLEL ARM BRACKET	13-A1900PABAL	10
	FRICTION TYPE - HOLD OPEN ARM MAXIMUM DOOR WEIGHT: 60 KG (132 LBS)	13-A1900FHOAL	10
	CUSH STOP ARM	13-A1900CSAAL	10
	CUSH STOP HOLD OPEN ARM MAXIMUM DOOR WEIGHT: 60 KG (132 LBS)	13-A1900CSHOAAL	10
	EXTENDED LONG ROD AND SHOE	13-A1900ELRSAL	50
	THRU BOLTS	13-A1900SNBAL	10
	SCREW PACK	13-A1900SPAL	10